

McNICHOL OF THE BLACK ISLE [Square Set] MacNab I 10 R104

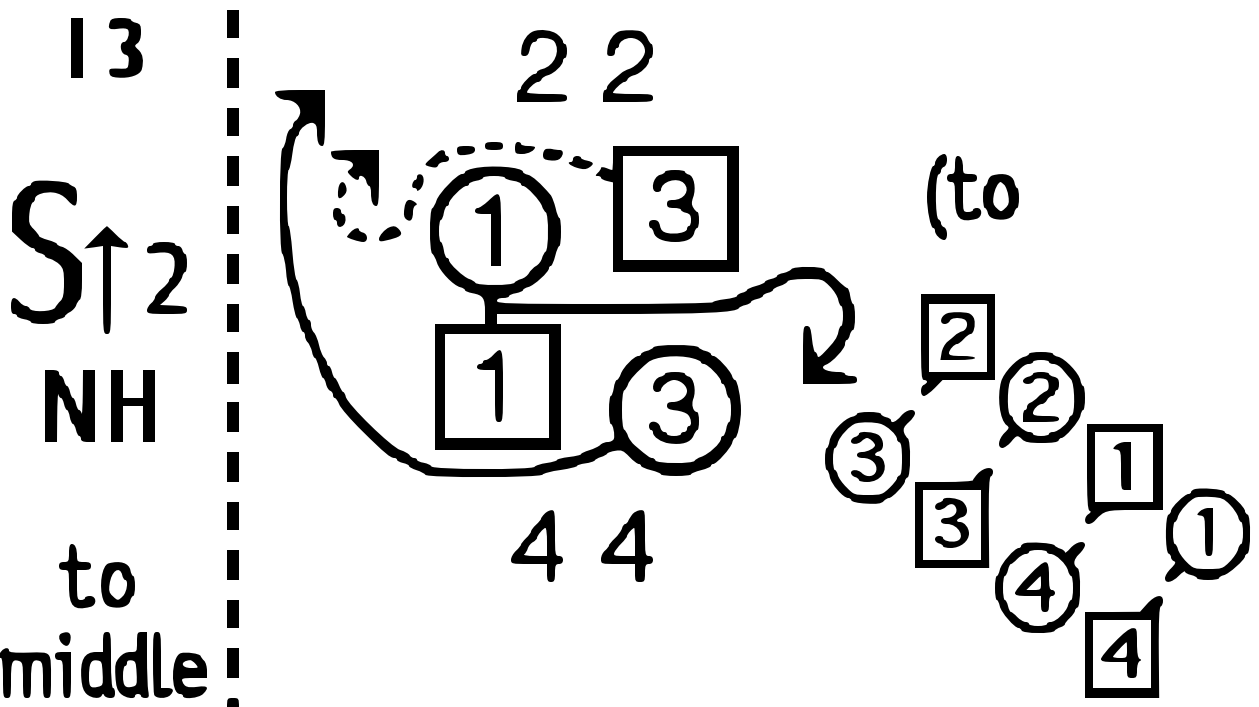

32+41
RA
LA

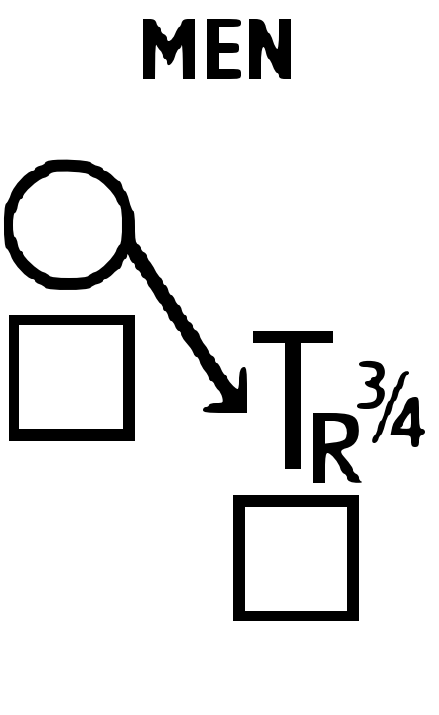
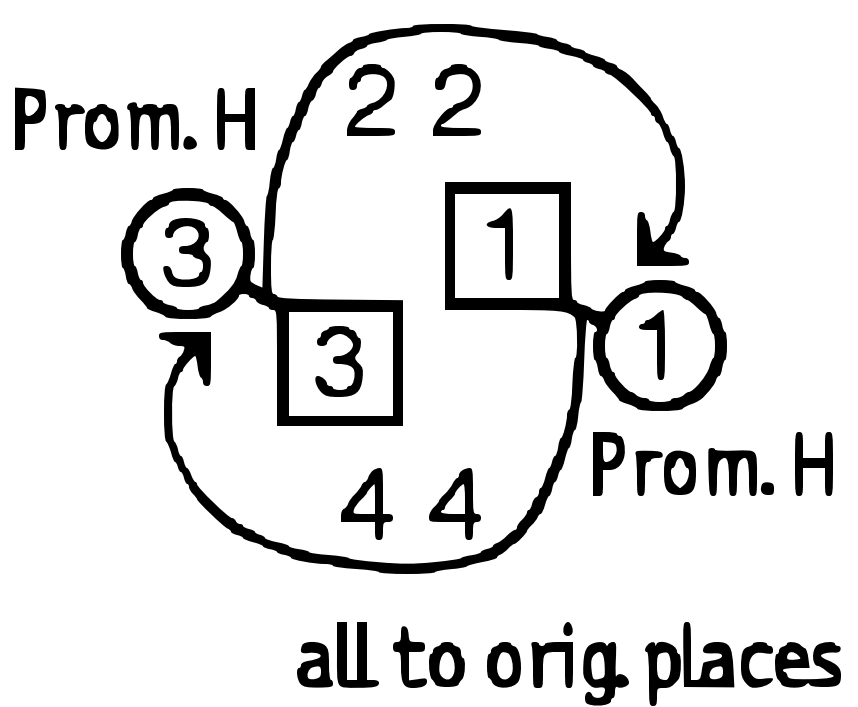
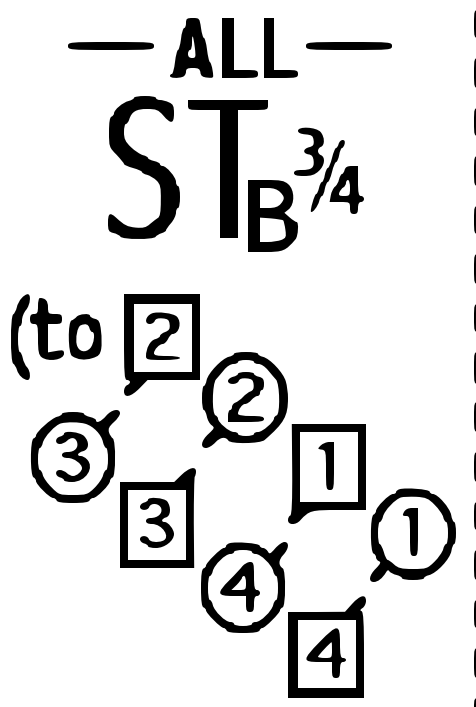
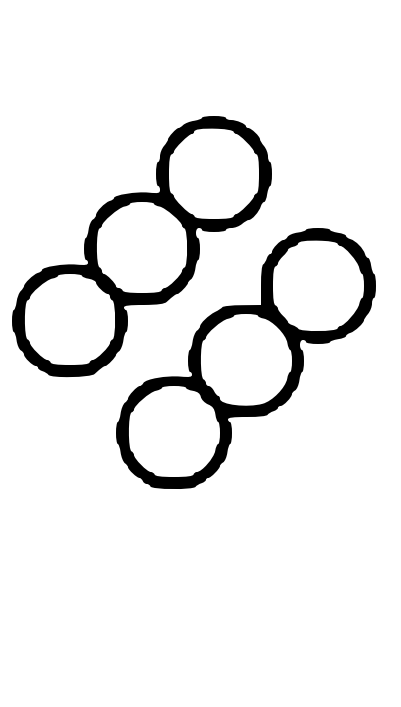
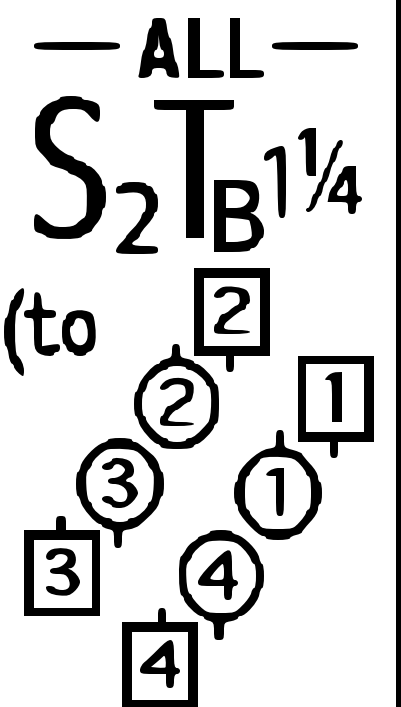

R R R
to place

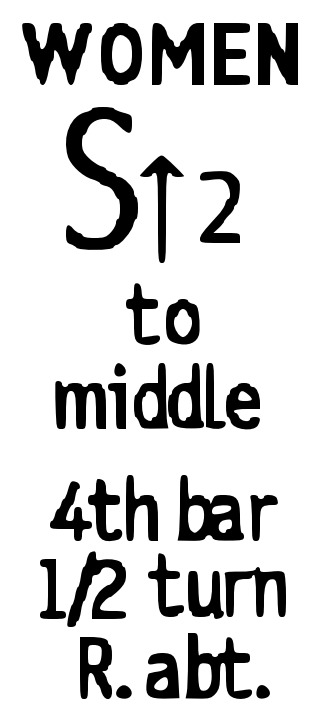

ALL
S₂
to partner

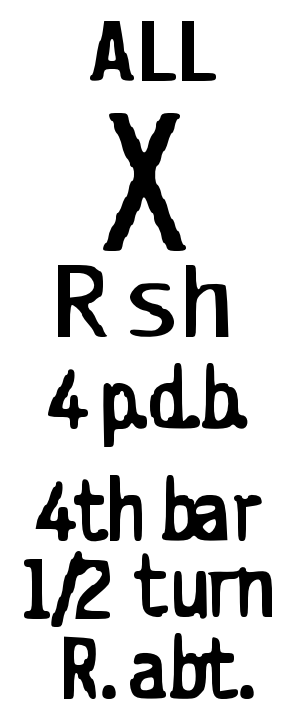

ALL
S₂
to partner

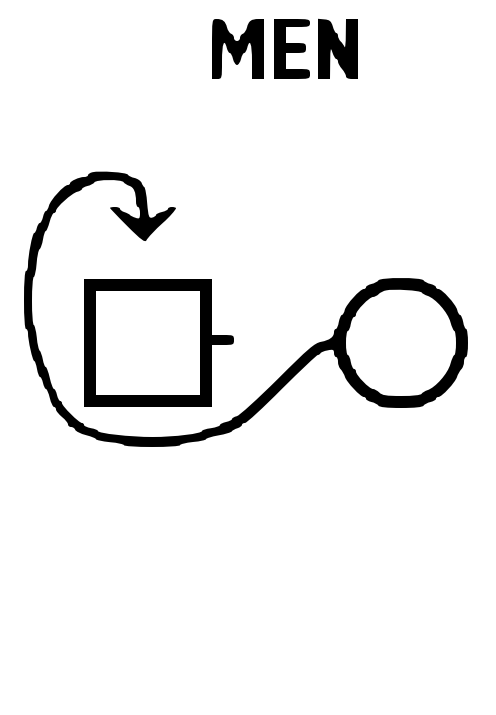

ALL
S₂
to partner

CHAIN
16 bars

— ALL —
S₂T_B