

IT'S JUST FOR FUN

Fidler: RSCDS XXXIII

** J32

X_R \uparrow
#(2)

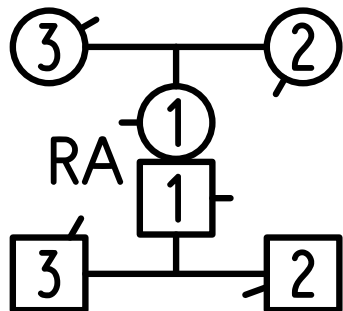
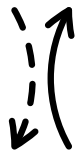
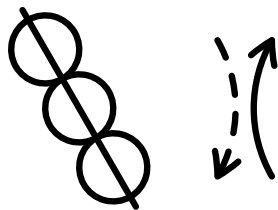
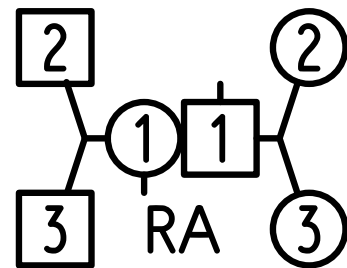
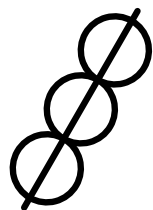
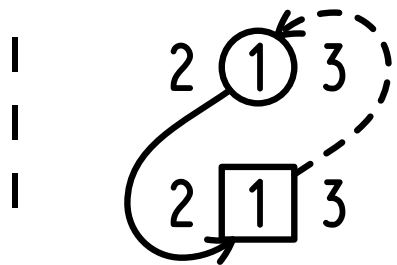

1 3 2
 $\underbrace{\begin{matrix} \text{L} \\ \text{X}_R \end{matrix}}$

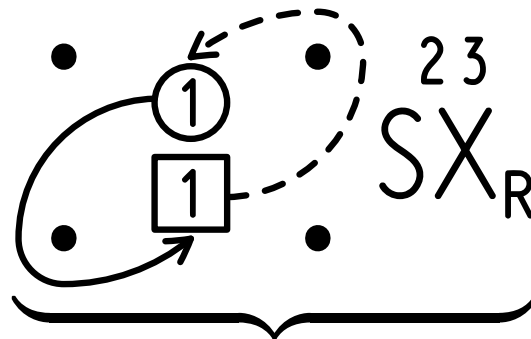

2 3
 2 1 3
 S